

PEDESTAL SPECIFICATIONS

Pedestal Assembly

- Assembly up to 900mm FFH shall provide a minimum 2270 kg axial load without permanent deformation.
- Assembly shall provide a 50mm total adjustment.

Pedestal Head

- 4mm thick die formed white zinc coated 4 pin steel pedestal head resistance welded to a threaded rod with adjustment nut. Head and installed stringers to provide full perimeter edge support for panel.
- Pedestal head shall have tapped holes for engagement of cornerlock screws and shall incorporate locating points to laterally contain and positively position the floor panel with or without the use of screws.
- Cornerlock fastener shall be M6 flat-head machine screw.
- Solid steel stud shall be 3/4" - 10 UNC.
- White zinc coated nut shall be 3/4" - 10 UNC and shall include an anti-rotation feature when engaged onto the base assembly.
- Stud shall provide an anti-rotation feature when engaged with the pedestal base assembly.

Pedestal Gasket

- Pedestal head gasket shall engage with stringers and panel to form a UFAD air seal

Pedestal Base

- Pedestal tube to be 28mm diameter white zinc coated tubing and shall be reduced to 19mm inner diameter by crimping.
- Base to be at least 230cm² and white zinc coated steel with (4) 11mm diameter holes for mechanical fastening applications

Stringers

- Heavy duty steel box stringer shall be 32mm deep x 21mm wide with factory applied foam gasket and shall withstand 200kg mid-span load.
- Stringer shall have hot dipped galvanized coating to prevent corrosion.
- Stringer grid pattern shall be 60cm x 60cm

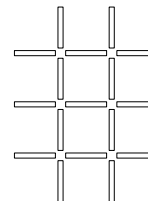
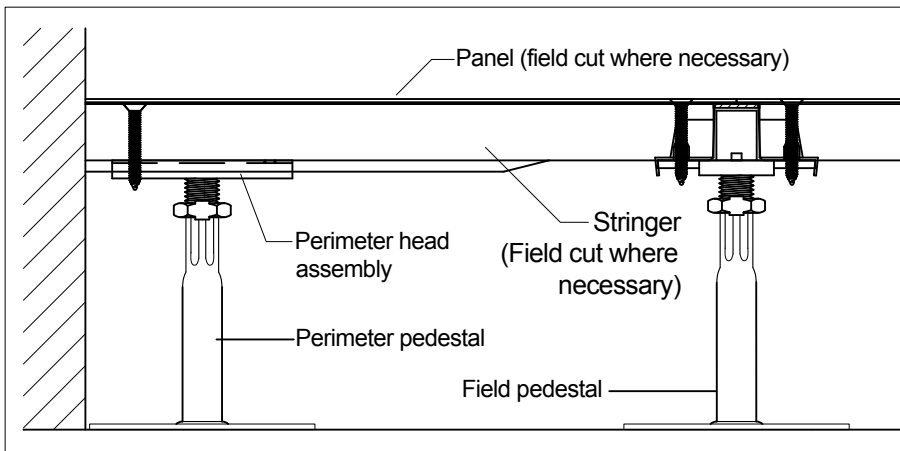

- Perimeter pedestal shall provide support for panels around columns, at walls, curbs and fascia.